

Structure and Chemistry of 1-Silafluorenyl Dianion, Its Derivatives, and an Organosilicon Diradical Dianion

Yuxia Liu, Thomas C. Stringfellow, David Ballweg, Iliia A. Guzei, and Robert West*

Contribution from the Organosilicon Research Center, Department of Chemistry,
University of Wisconsin, Madison, Wisconsin 53706

Received July 26, 2001

Abstract: 1-Silafluorene dianion was synthesized by potassium reduction of 1,1-dichloro-1-silafluorene in refluxing THF. The X-ray structure of 1,1-dipotassio-1-silafluorene (**3b**) shows C–C bond length equalization in the five-membered silole ring and C–C bond length alternation in the six-membered benzene rings, indicating aromatic delocalization of electrons in the silole ring. The downfield ^{29}Si chemical shift at 29.0 ppm and theoretical calculations also support electron delocalization in the silole ring of **3b**. Dianion salt **3b** underwent nucleophilic reactions with Me_3SiCl and EtBr to form the corresponding disubstituted products. Benzaldehyde underwent reductive coupling in the presence of **3b**. Slow oxidation of **3b** yielded 1,1'-dipotassio-1,1'-bis(silafluorene) (**16**). The X-ray structure and ^{29}Si chemical shift (-38.0 ppm) of **16** indicate localized negative charges at the silicon atoms and no aromatic character. Heating a DME/hexane solution of **3b** in the presence of 18-crown-6 led to a novel diradical dianion salt.

Introduction

The first silole dianion salt (**1**, $\text{R} = \text{Ph}$) was reported by Joo and co-workers in 1990 (Scheme 1).¹ Since then, the structures and chemistry of silole dianions and their analogues have been areas of great interest.^{2–8} Silole dianions are believed to be aromatic, with delocalization of the electrons and C–C bond equalization in the five-membered silole ring, based on the crystal structure,^{5,6} NMR spectroscopy,³ and theoretical studies.⁸ Silole dianions undergo nucleophilic reactions,¹ single electron-transfer reactions,⁹ and polymerization to form polysilole polymers and copolymers having fluorescent and electroluminescent properties.¹⁰ Recently, Boujouk and co-workers synthesized silaindenyl dianion salt **2** by reduction of a dichlorosilaindene with lithium.¹¹ The ^{29}Si NMR spectra and X-ray structure of **2** likewise indicated aromatic delocalization in the silole ring, with bond-length alternation in the benzene ring.

Choi and Boudjouk¹² and our group¹³ have reported the synthesis of silafluorenyl dianions salts (**3a,b**) from the reduction of dichlorosilafluorene (**4**) with alkali metals. Choi and Boud-

Scheme 1

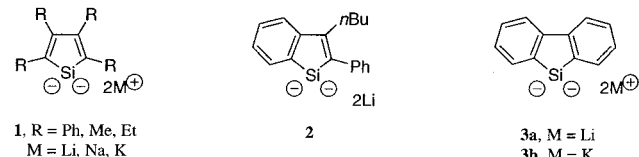

Scheme 2

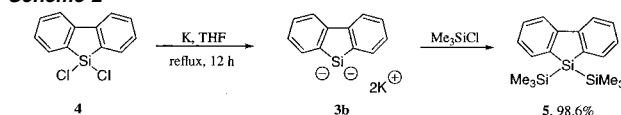

jouk found that reduction of **4** with lithium gave a green solution containing the dilithium salt **3a**. Derivatization of the solution with Me_3SiCl gave trisilane **5** in 95% yield. The ^{29}Si chemical shift of this dilithiosilafluorenyl dianion salt **3a** was reported to be -1.09 ppm, shifted upfield from the precursor **4** (6.8 ppm). Thus the dianion in **3a**, unlike the other silole dianions, was believed to be nonaromatic with the negative charges localized on the silicon atom.¹² In our case, reduction of **4** with potassium in refluxing THF yielded a dark red solution containing dianion salt **3b**. Reaction of this solution with Me_3SiCl gave trisilane **5** in 99% yield (Scheme 2).¹³ The ^{29}Si chemical shift ($\delta = 29.0$ ppm) of **3b** indicated considerable electron delocalization in the five-membered silole ring, and thus we proposed that the silafluorene dianion in **3b** has aromatic character.¹³

In this paper, we report the X-ray structural analysis of **3b**. The crystal structure of **3b** indicates C–C bond length equalization in the five-membered silole ring, confirming our previous view about the aromaticity of **3b**. The mechanistic considerations of the potassium reduction reaction, a comparison of the ^{29}Si chemical shifts of **3b** and other known dianion salts, and several chemical reactions of **3b** will be discussed.

- Joo, W.-C.; Hong, J.-H.; Choi, S.-B.; Son, H.-E. *J. Organomet. Chem.* **1990**, *391*, 27.
- Hong, J.-H.; Boudjouk, P. *J. Am. Chem. Soc.* **1993**, *115*, 5883.
- Hong, J.-H.; Boudjouk, P.; Castellino, S. *Organometallics* **1994**, *13*, 3387.
- Bankwitz, U.; Sohn, H.; Powell, D. R.; West, R. *J. Organomet. Chem.* **1995**, *499*, C7.
- West, R.; Sohn, H.; Bankwitz, J.; Calabrese, J.; Apeloig, Y.; Müller, T. *J. Am. Chem. Soc.* **1995**, *117*, 11608.
- Freeman, W. P.; Tilley, T. D.; Liabre-Sands, L. M.; Rheingold, A. L. *J. Am. Chem. Soc.* **1996**, *118*, 10457.
- Freeman, W. P.; Tilley, T. D.; Yap, G. P. A.; Rheingold, A. L. *Angew. Chem., Int. Ed. Engl.* **1996**, *35*, 882.
- Goldfuss, B.; Scheleyer, P. v. R. *Organometallics* **1997**, *16*, 1543.
- Liu, Y.; West, R. *Abstracts of Papers*, 32nd Organosilicon Symposium, Milwaukee, WI, March 12–13, 1999; p P-2.
- West, R.; Sohn, H.; Liu, Y. U. S. Patent 6,169,193 B1, 2001.
- Choi, S.-B.; Boudjouk, P.; Wei, P. *J. Am. Chem. Soc.* **1998**, *120*, 5814.
- Choi, S.-B.; Boudjouk, P. *Tetrahedron Lett.* **2000**, *41*, 6685.
- Liu, Y.; West, R. *Abstracts of Papers*, 34th Organosilicon Symposium, Saginaw, MI, April 6–8, 2000; p PA-14.

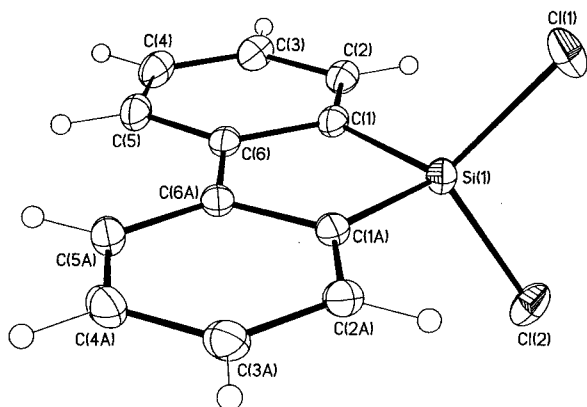
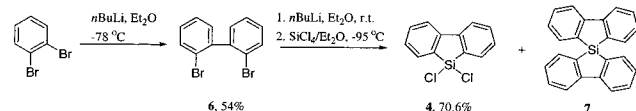

Figure 1. Thermal ellipsoid diagram of structure **4**. Selected bond angles ($^{\circ}$): C(1)–Si(1)–C(1A) = 94.70(10), C(1)–Si(1)–Cl(1) = 114.95(5), C(1)–Si(1)–Cl(2) = 112.84(5), Cl(1)–Si(1)–Cl(2) = 106.53(4), C(6)–C(1)–Si(1) = 107.14(11), C(1)–C(6)–C(6A) = 115.51(9).

Scheme 3



Results and Discussion

Synthesis of Dipotassium Salt 3b. The preparation^{14,15} of the starting material, 1,1-dichloro-1-silafluorene (**4**), has been described previously. Although the unit cell was determined in an earlier paper,¹⁶ the crystal structure was never published. We have improved the preparation method (Scheme 3) and determined the X-ray crystal structure of **4**, shown as a thermal ellipsoid diagram in Figure 1.

As reported earlier,¹⁴ lithiation of **6** and then treatment with SiCl_4 at room temperature gave mostly spiro-silafluorene **7** and small amounts of **4** (22%). However, by using excess SiCl_4 and carrying out the reaction at $-95\text{ }^{\circ}\text{C}$, we obtained a 71% yield of **4**.

Reaction of **4** with potassium metal led to an insoluble white solid, probably a polysilafluorene (**8**) (Scheme 4). Further reaction with potassium cleaved the Si–Si bonds in the polymer chain. Trapping with Me_3SiCl followed by ^1H NMR spectroscopy was used to monitor the reaction process. After 3 h at room temperature, trisilane **5**, tetrasilane **9**, and pentasilane **10** were observed in a ratio of 1:4:2. The X-ray crystal structure of **10** is shown as a thermal ellipsoid diagram in Figure 2.

Complete cleavage of Si–Si bonds occurred after 2 h of refluxing in THF, yielding silafluorenyl dianion salt **3b**. Me_3SiCl trapping of the reaction mixture then gave exclusively trisilane **5**.

X-ray Crystal Structure and Unit Cell of 3b. Crystals of the intensely reactive dipotassium salt of **3b** were obtained by crystallization from DME/hexane in the presence of 18-crown-6 ether, allowing the structure to be determined by X-ray crystallography. A thermal ellipsoid diagram for the dianion salt is shown in Figure 3. One of the two potassium atoms is η^5 -bonded to the silole ring; the other is η^1 -bonded to the silicon

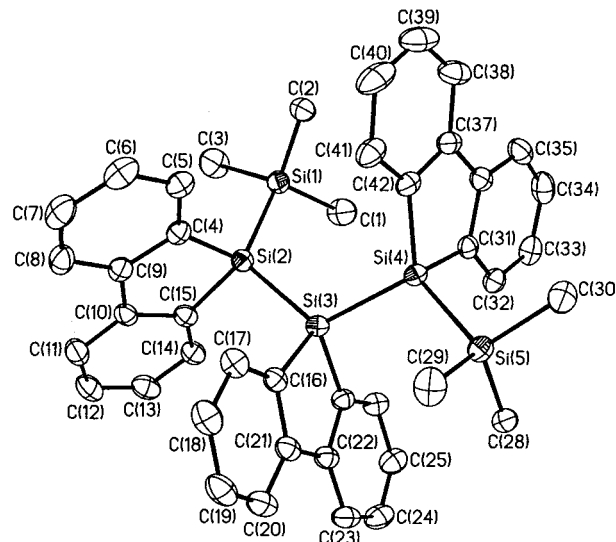
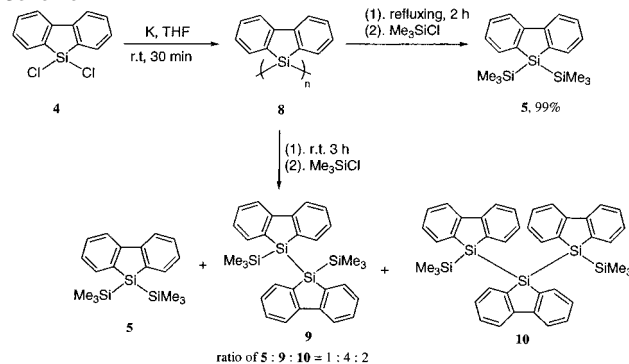

Figure 2. Thermal ellipsoid diagram of structure **10**. Selected bond lengths (\AA) and angles ($^{\circ}$): Si(1)–Si(2) = 2.3417(9), Si(2)–C(4) = 1.880(2), Si(2)–Si(3) = 2.3426(9), Si(3)–C(16) = 1.881(2), C(4)–C(9) = 1.413(3), C(9)–C(10) = 1.485(3), C(16)–C(21) = 1.415(3), C(21)–C(22) = 1.483(3), C(15)–Si(2)–C(4) = 91.37(10), C(4)–Si(2)–Si(1) = 114.15(7), C(4)–Si(2)–Si(3) = 106.58(7), Si(1)–Si(2)–Si(3) = 120.01(3), C(16)–Si(3)–C(27) = 91.13(10), C(16)–Si(3)–Si(2) = 110.73(8), Si(2)–Si(3)–Si(4) = 117.97(3), Si(3)–Si(4)–Si(5) = 111.19(3), C(9)–C(4)–Si(2) = 109.05(16), C(4)–C(9)–C(10) = 115.3(2), C(21)–C(16)–Si(3) = 109.12(16), C(16)–C(21)–C(22) = 115.4(2).

Scheme 4



atom. The same arrangement of the alkali metals was found in the salts of the silole and silaindene dianions.^{5,11}

The unit cell for **3b**, shown in Figure 4, contains three silafluorenyl anions, six potassium cations, five 18-crown-6 ethers, and two solvated molecules of hexane. The K cation η^5 -bonded to the silole ring is also coordinated to the six oxygen atoms of an 18-crown-6 molecule; the other potassium, η^1 -bonded to the Si atom, is coordinated to four oxygen atoms of an 18-crown-6 molecule. One 18-crown-6 molecule occupies a crystallographic inversion center. The unit cell contains an inversion center, and therefore only one-half of the unit cell content is symmetry-independent.

Reactions of Dianion Salt 3b. Some reactions of **3b** are shown in Scheme 5. Nucleophilic substitutions with both Me_3SiCl and EtBr gave high yields of corresponding disubstituted products, **5** and **11**. Reaction with an excess of MeI at room temperature yielded three major products, 1,1-dimethyl-1-silafluorene (**12**), 1,1'-dimethyl-1,1'-disilafluorene (**13**), and 1,1'-dimethyl-1,1'-disilafluorene-1,1'-dioxane (**14**), in a ratio of 5:2:1. Disiloxane **14** probably arises from hydrolysis of 1-methyl-

(14) Gilman, H.; Gorsich, R. D. *J. Am. Chem. Soc.* **1958**, *80*, 1883.

(15) Corey, J. Y.; John, C. S.; Ohmsted, M. C.; Chang, L. S. *J. Organomet. Chem.* **1986**, *304*, 93.

(16) Cherenkova, O. I.; Alekseev, N. V.; Gusev, A. I. *J. Struct. Chem. (Engl. Transl.)* **1975**, *16*, 477.

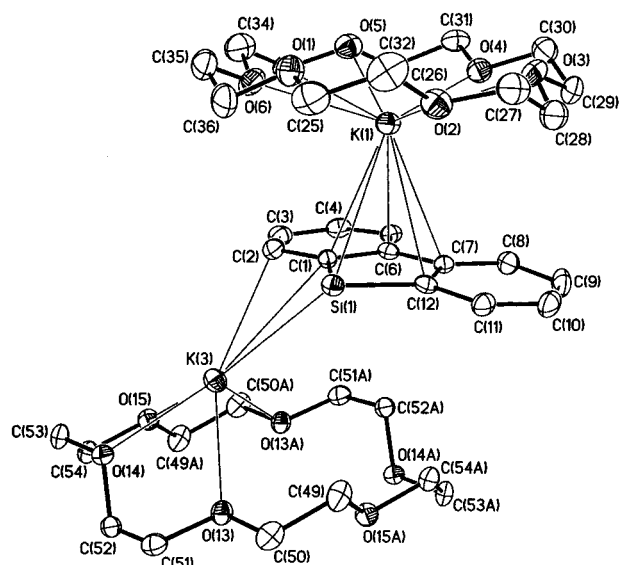

Figure 3. Thermal ellipsoid diagram of structure **3b**. Selected bond lengths (Å) and angles (°): K(1)–Si(1) = 3.3736(15), Si(1)–C(1) = 1.865(4), Si(1)–C(12) = 1.867(4), K(1)–C(1) = 3.312(4), K(1)–C(6) = 3.347(4), K(1)–C(7) = 3.309(4), K(1)–C(12) = 3.277(4), C(1)–C(2) = 1.428(6), C(1)–C(6) = 1.451(5), C(2)–C(3) = 1.373(6), C(3)–C(4) = 1.394(6), C(4)–C(5) = 1.380(6), C(5)–C(6) = 1.427(6), C(6)–C(7) = 1.457(6), C(7)–C(12) = 1.431(5), C(1)–Si(1)–C(12) = 87.12(18), Si(1)–C(1)–C(6) = 113.7(3), C(1)–C(6)–C(7) = 112.0(3), C(6)–C(7)–C(12) = 113.5(3), C(7)–C(12)–Si(1) = 113.6(3), C(2)–C(1)–C(6) = 114.6(4), C(1)–C(2)–C(3) = 123.6(4), C(2)–C(3)–C(4) = 120.1(4), C(3)–C(4)–C(5) = 120.9(4), C(4)–C(5)–C(6) = 119.4(4), C(5)–C(6)–C(1) = 121.3(4), C(1)–K(1)–C(6) = 25.2, C(6)–K(1)–C(7) = 25.3, C(7)–K(1)–C(12) = 25.1, C(12)–K(1)–Si(1) = 32.6, C(1)–K(1)–Si(1) = 32.4, C(12)–Si(1)–K(3) = 133.1, C(1)–Si(1)–K(3) = 78.0.

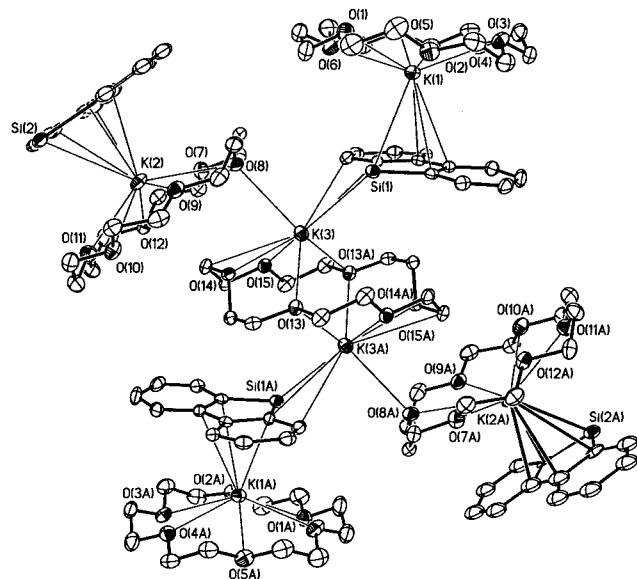

Figure 4. Unit cell for **3b**.

1-iodo-1-silafluorene during workup. Apparently, not only a nucleophilic reaction but also a radical process may be involved, accounting for the formation of **13** and **14**. Dianion salt **3b** reacted with benzaldehyde, promoting reductive coupling of the carbonyl groups to give a 1,2-diol exclusively. Single electron transfer (SET) from **3b** to the carbonyl of benzaldehyde is believed to be the first step of the reaction.¹⁷ An oligosilafluorene (**15**) was also isolated from this reaction in 56% yield. A radical homopolymerization may have taken place among the radical species generated from **3b** after SET. The modest yield of **15** suggests that insoluble high polymeric polysilafluorene may have formed but was removed by filtration during workup.

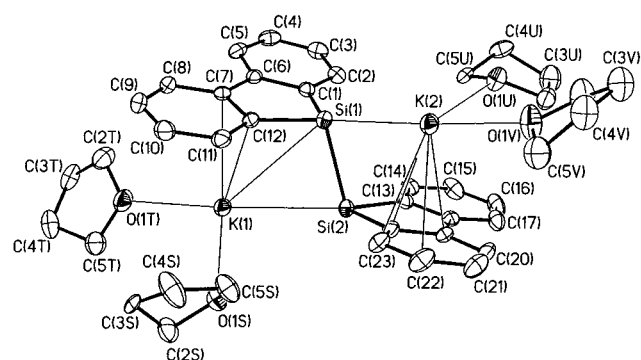

Figure 5. Thermal ellipsoid diagram of structure **16**. Selected bond angles (°): C(1)–Si(1)–C(12) = 87.82(13), C(1)–Si(1)–Si(2) = 107.07(10), C(12)–Si(1)–K(2) = 123.19(9), C(1)–Si(1)–K(2) = 142.34(9), Si(2)–Si(1)–K(2) = 85.89(3), C(1)–Si(1)–K(1) = 116.94(10), C(12)–Si(1)–K(1) = 54.04(9), C(1)–Si(1)–K(1) = 75.39(9), Si(2)–Si(1)–K(1) = 60.97(3), K(2)–Si(1)–K(1) = 138.66(3), C(6)–C(1)–Si(1) = 111.7(2), C(1)–C(6)–C(7) = 113.8(2), C(8)–C(7)–K(1) = 100.16(18), C(12)–C(7)–K(1) = 75.40(17), C(6)–C(7)–K(1) = 93.56(18), C(11)–C(12)–K(1) = 97.76(19), Si(1)–C(12)–K(1) = 96.65(11).

rene (**15**) was also isolated from this reaction in 56% yield. A radical homopolymerization may have taken place among the radical species generated from **3b** after SET. The modest yield of **15** suggests that insoluble high polymeric polysilafluorene may have formed but was removed by filtration during workup.

Oxidation. Upon long standing, slow oxidation of **3b** in THF/hexane solution takes place leading to formation of the dimerized dianion salt, **16**, which was trapped with Me₃SiCl to give the tetrasilane **9** (Scheme 6).

A red crystal of **16** was isolated from the THF/hexane solution, and its structure was determined by X-ray crystallography. A thermal ellipsoid diagram for the dimer dianion salt is shown in Figure 5. Remarkably, each potassium cation is η¹-bonded to a silicon atom of one silole ring and η⁵-bonded to the other silole ring. Two THF molecules are coordinated to each potassium cation.

Thermal Reaction. Dianion salt **3b** reacted with DME when heated in DME/hexane solution in the presence of 18-crown-6 and potassium metal at 60–70 °C (Scheme 7). The color of the solution changed from dark red to green after 12 h. The product was isolated as dark green crystals, which were shown by X-ray crystallography to be a diradical dianion salt, **17**. A thermal ellipsoid diagram for **17** is shown in Figure 6. Each potassium atom is η⁵-bonded to one silole ring and also coordinated to an 18-crown-6 molecule. **17** is a unique example of an organosilicon diradical dianion. One example of a diboron dianion diradical has recently been reported.¹⁸

Figure 7 shows the room temperature EPR spectrum (top) and simulated spectrum (bottom) of a reaction mixture containing primarily **17** in DME/hexane with the presence of potassium counterion and 18-crown-6. The central resonance appears at $g = 2.0027$, and the line width is $\Delta B_{pp} = 0.24$ G. Hyperfine coupling is well enough resolved to identify the dominant electron–nuclear hyperfine splitting parameters $a_1(2,^1\text{H}) = 4.2$ G, $a_2(4,^1\text{H}) = 0.98$ G, and $a_3(2,^1\text{H}) = 0.56$ G, and a fourth component, $a_4 = 16$ G, that appears to arise from coupling to a less abundant spin-¹/₂ nuclide such as ²⁹Si or ¹³C. Such a spectrum is consistent with delocalization of an odd electron

(17) Liu, Y.; West, R. *Abstracts of Papers*, 36th Organic Chemistry Symposium, Madison, WI, June 13–17, 1999; Abstract No. 161.

(18) Rajca, A.; Rajca, S.; Desai, S. R. *J. Chem. Soc., Chem. Commun.* **1995**, 1957.

Scheme 5

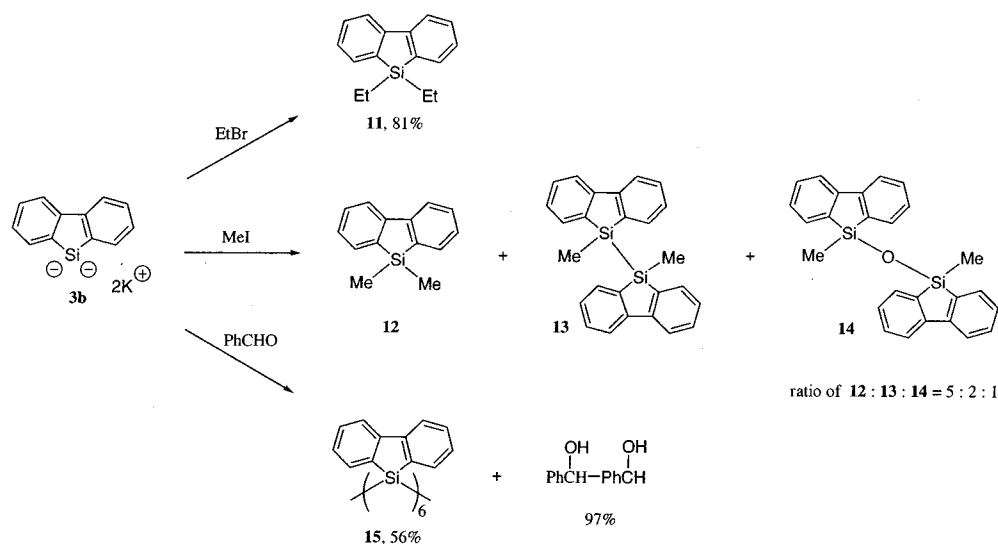

Scheme 6

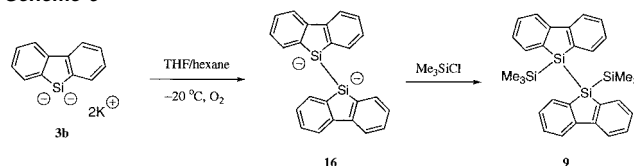

Scheme 7

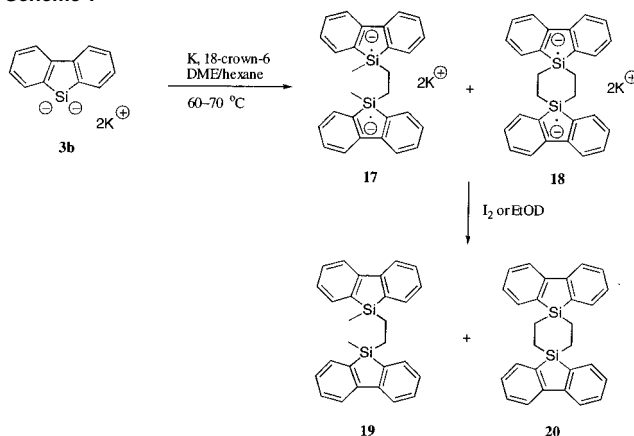

throughout the aromatic rings of the molecule. Additional minor resonances are present but unassigned; these are speculated to arise from interaction with the counterion K⁺.

Density functional calculations were performed to complement the experimental data. Using the Gaussian 98 program suite¹⁹ with the UB3LYP/6-31++G** model chemistry, the geometry of the model structure 1,1-dimethyl-1-silafluorene (**12**) was first fully optimized, and the EPR hyperfine splitting parameters were computed. The hyperfine splitting parameters

thus obtained are illustrated in Figure 8. The calculated splitting parameters are in very good agreement with the experimentally observed values and suggest that perhaps the methyl carbon nuclei, rather than the single silicon nucleus, are responsible for the signals observed at ±8 G. However, the intensity of the resonances observed at ±8 G is more faithfully reproduced when the signals are attributed to ²⁹Si (at 4.7% natural abundance) rather than ¹³C (2 at 1.1% natural abundance).

No spectral evidence for a triplet-state radical could be observed; neither a half-field resonance nor characteristic dipolar line shapes for the single-quantum transitions could be seen in frozen solution at -196 °C.²⁰

Reaction of the green solution with I₂ or EtOD after 12 h of heating gave mainly compound **19**. However, if the green solution was continuously heated for a week and then allowed to react with I₂, two products, **19** and **20**, were isolated in a ratio of 10:1. Formation of **20** suggests that a precursor, a new diradical dianion salt **18**, may have formed after the solution was heated for a long time. A single crystal of **20** was isolated, and the structure was determined by X-ray crystallography. A thermal ellipsoid diagram for **20** is shown in Figure 9. The molecule of **20** has crystallographic C_i symmetry with the central six-membered 1,4-disila ring in a perfect chair conformation.

A possible mechanism for the formation of **17** and **18** is proposed in Scheme 8. Dianion salt **3b** may undergo nucleophilic substitution with DME molecules at an elevated temperature and in the presence of 18-crown-6 to yield first an anion salt **21** and then dimethylsilafluorene **12**. Reaction of **12** with 2 equiv of K results in anion salt **22**, which is stabilized by the α-silafluorenyl moiety and could have considerable diradical character, as shown in the structure of **23**. Dimerization of **23** yields the diradical dianion salt **17**. Upon heating for a long time, some of **17** may undergo oxidation with O₂, probably from the Ar supply, to form neutral species **19**. Further reaction of **19** with potassium metal, followed by intramolecular dimerization, gave the diradical dianion salt **18**. This new diradical dianion salt **18**, although not isolated, reacts with I₂ to give product **20**.

To verify the proposed mechanism, especially the existence of the neutral intermediate **12** in the reaction, compound **12**

(19) Frisch, M. J.; Trucks, G. W.; Schlegel, H. B.; Scuseria, G. E.; Robb, M. A.; Cheeseman, J. R.; Zakrzewski, V. G.; Montgomery, J. A., Jr.; Stratmann, R. E.; Burant, J. C.; Dapprich, S.; Millam, J. M.; Daniels, A. D.; Kudin, K. N.; Strain, M. C.; Farkas, O.; Tomasi, J.; Barone, V.; Cossi, M.; Cammi, R.; Mennucci, B.; Pomelli, C.; Adamo, C.; Clifford, S.; Ochterski, J.; Petersson, G. A.; Ayala, P. Y.; Cui, Q.; Morokuma, K.; Malick, D. K.; Rabuck, A. D.; Raghavachari, K.; Foresman, J. B.; Cioslowski, J.; Ortiz, J. V.; Baboul, A. G.; Stefanov, B. B.; Liu, G.; Liashenko, A.; Piskorz, P.; Komaromi, I.; Gomperts, R.; Martin, R. L.; Fox, D. J.; Keith, T.; Al-Laham, M. A.; Peng, C. Y.; Nanayakkara, A.; Gonzalez, C.; Challacombe, M.; Gill, P. M. W.; Johnson, B.; Chen, W.; Wong, M. W.; Andres, J. L.; Head-Gordon, M.; Replogle, E. S.; Pople, J. A. *Gaussian 98*, revision A.9; Gaussian, Inc.: Pittsburgh, PA, 1998.

(20) Kahn, O. *Molecular Magnetism*; VCH: New York, 1993.

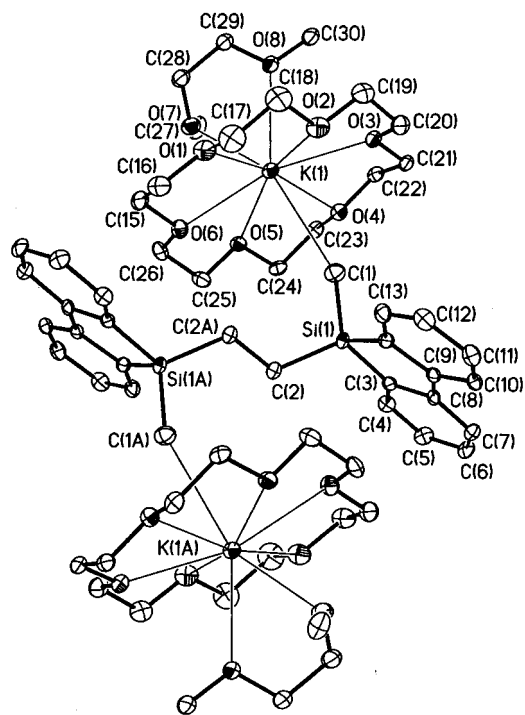

Figure 6. Thermal ellipsoid diagram of structure **17**. Selected bond angles ($^{\circ}$): C(3)–Si(1)–C(14) = 91.96(18), C(3)–Si(1)–C(1) = 115.2(2), C(14)–Si(1)–C(1) = 113.0(2), C(3)–Si(1)–C(2) = 112.4(2), C(14)–Si(1)–C(2) = 117.4(2), C(1)–Si(1)–C(2) = 106.7(2), Si(1)–C(1)–K(1) = 156.2(2), C(2A)–C(2)–Si(1) = 115.8(4), C(8)–C(3)–Si(1) = 109.0(3), C(7)–C(8)–C(3) = 117.5(4), C(9)–C(8)–C(3) = 115.7(3), C(8)–C(9)–C(14) = 115.2(4), C(13)–C(14)–Si(1) = 133.3(3), C(9)–C(14)–Si(1) = 108.2(3).

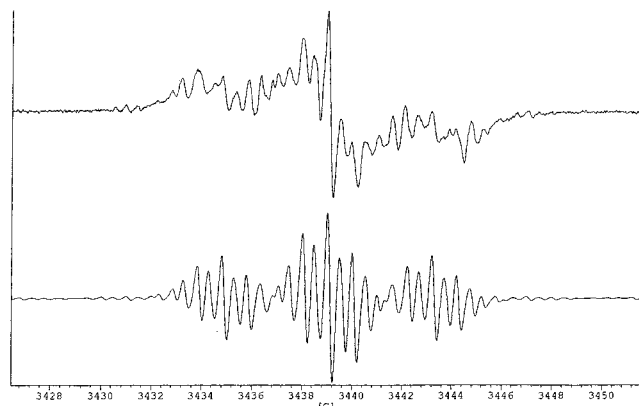

Figure 7. EPR spectrum (top) and simulated spectrum (bottom) of a reaction mixture containing **17** in DME/hexane and 18-crown-6. The simulated spectrum was generated with the hyperfine splitting parameters $a_1(2,^1\text{H}) = 4.2$ G, $a_2(4,^1\text{H}) = 0.98$ G, $a_3(2,^1\text{H}) = 0.56$ G, and $a_4(1,^{29}\text{Si}) = 16.0$ G.

was prepared separately by reacting 2,2'-biphenyl with *n*-BuLi and then Me_2SiCl_2 . Potassium reduction of **12**, either with or without 18-crown-6 present, yielded a green solution. Oxidation of the green solution with I_2 gave back mostly **12** along with some unidentified polymeric material. The green color may result from the formation of the radical anion of dimethylsilafluorene.²¹ Lithium reduction of **12** at room temperature over one week formed a small amount of the lithium salts corre-

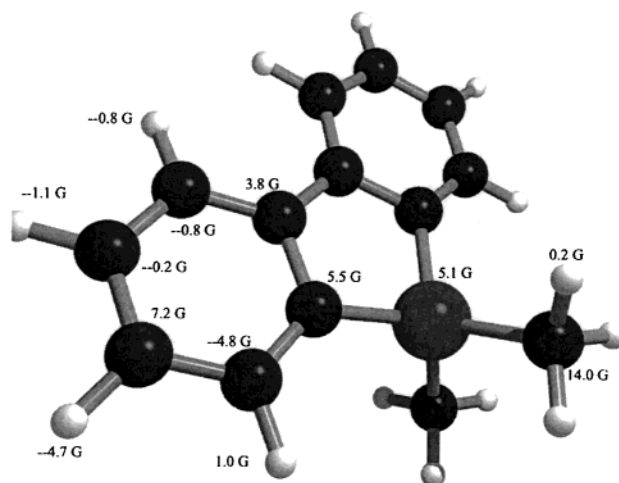

Figure 8. EPR hyperfine splitting parameters calculated for the related structure 1,1-dimethyl-1-silafluorene (**12**) at the UB3BLP/6-31++G** level.

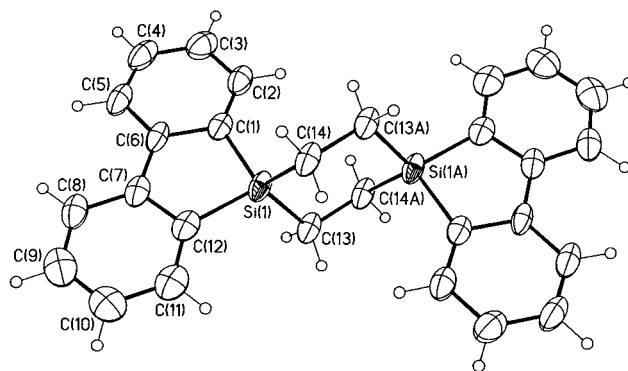

Figure 9. Thermal ellipsoid diagram of **20**. Selected bond lengths (\AA) and angles ($^{\circ}$): Si(1)–C(1) = 1.861(3), Si(1)–C(12) = 1.867(3), Si(1)–C(13) = 1.873(3), Si(1)–C(14) = 1.874(3), C(1)–C(6) = 1.420(4), C(6)–C(7) = 1.481(4), C(7)–C(12) = 1.399(4), C(13)–C(14A) = 1.540(4), C(1)–Si(1)–C(12) = 91.55(13), C(1)–Si(1)–C(13) = 112.84(13), C(1)–Si(1)–C(14) = 113.99(12), C(13)–Si(1)–C(14) = 108.30(12), C(6)–C(1)–Si(1) = 108.8(2), C(1)–C(6)–C(7) = 115.2(2), C(7)–C(12)–Si(1) = 109.7(2), C(14A)–C(13)–Si(1) = 112.91(19).

sponding to **17** and **18**; after oxidation with I_2 , the mixture gave **12**:**19**:**20** in a ratio of 15:4:1 based on ^1H NMR data.

X-ray Structure Analysis. Selected bond lengths for **3b**, **4**, **16**, and **17** are shown in Figure 10, and crystal parameters for these compounds are given in Table 1. The five-membered silole ring in dianion salt **3b** has nearly equal C–C bond lengths, and a K(1) atom sits above and η^5 -bonds to the ring, indicating a high degree of delocalization of a lone pair of electrons and the other four π electrons. Bond alternation, indicating some localization of electron density, is found in the two six-membered benzene rings of **3b**. Thus aromatic delocalization into the silole ring of **3b** appears to take precedence over benzenoid delocalization. The η^1 K(2) is at the equatorial position with respect to the silole ring and has a short distance of 326.6 pm to Si(1), suggesting the localization of the second lone pair of electrons at the silicon atom.

The salt **16** has C–C bond length alternation in the silole rings, similar to the precursor dichloride **4**, indicating localization of the negative charge at the Si atom. The bond lengths between Si(1)–Si(2) (242.3 pm), Si(1)–C(1) (189.9 pm), and Si(1)–C(12) (189.3) are somewhat long, suggesting that these bonds are weakened by the lone pair at Si.

(21) Janzen, E. G.; Harrison, W. B.; Dubose, C. M., Jr. *J. Organomet. Chem.* **1972**, *40*, 281.

Scheme 8

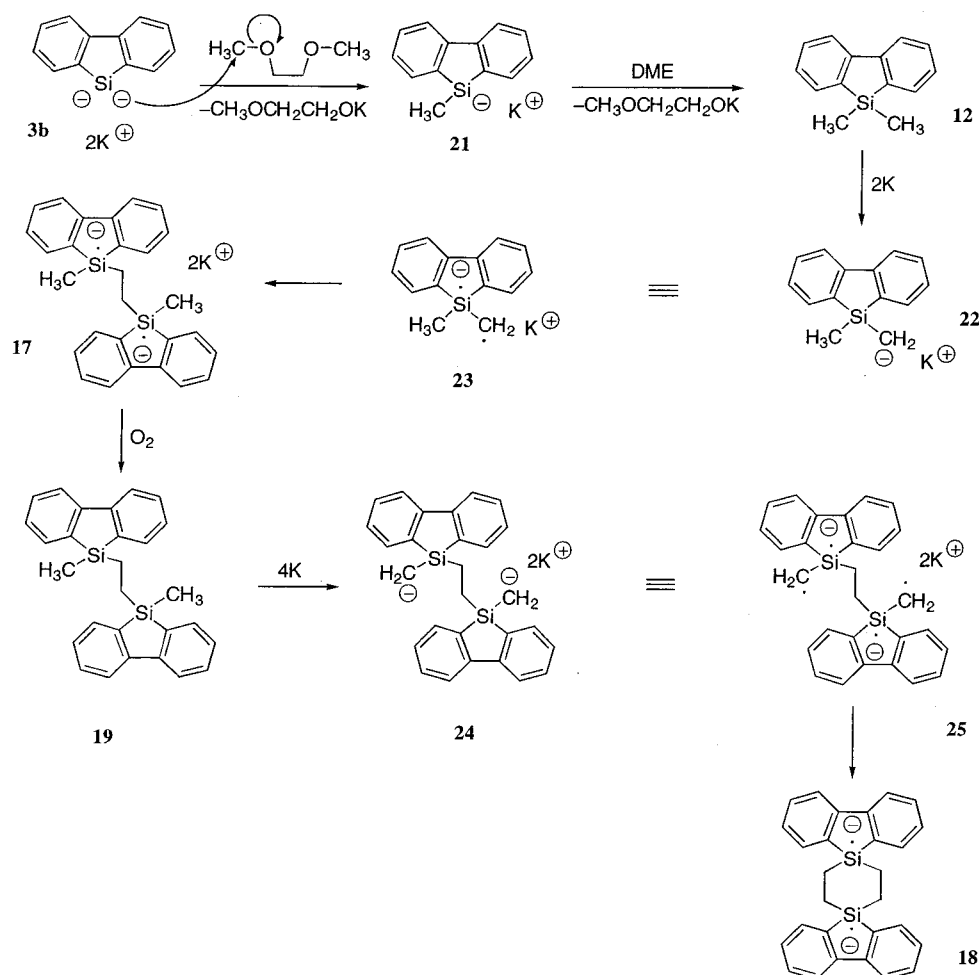

In the structure of the diradical dianion salt **17**, a slight C–C bond length alternation in the benzene rings indicates some loss of aromaticity in these rings, consistent with delocalization of the unpaired electrons into the LUMO of the biphenyl systems. Since the silicon atoms each have four σ bonds, delocalization into the five-membered ring is not possible.

NMR Study. Both the ^1H and ^{13}C NMR spectra of **3b** have patterns similar to those of the precursor **4** (Table 2), although the peaks of **3b** are broader, and coupling details are all lost. In the spectra of **3b**, both the ^1H and ^{13}C NMR resonances are spread out over wide ranges, from 8.42 to 6.36 ppm ($\Delta\delta = 2.06$) in ^1H NMR and from 167.9 to 110.5 ppm ($\Delta\delta = 57.3$) in ^{13}C NMR. In comparison, the peak ranges of **4** are 7.87–7.31 ppm ($\Delta\delta = 0.56$) in ^1H NMR and 146.8–122.1 ppm ($\Delta\delta = 24.7$) in ^{13}C NMR. Some degree of electron localization and loss of aromaticity in the benzenoid rings of **3b** might account for such chemical shift variations.

The ^{29}Si chemical shift is strongly correlated with the aromaticity of silole dianions. Table 3 lists ^{29}Si NMR chemical shifts for some of the known silole dianion salts. Dianion salt **3b** has a chemical shift of 29.0 ppm, a significant downfield shift from 5.7 ppm of its precursor **4**. Similar downfield shifts are observed for other known silole dianion salts, and such downfield shifting is consistent with delocalization of the negative charges into the five-membered silole ring. Interestingly, the resonance for the dimer dianion salt **16** is shifted upfield (–38.0 ppm), and thus the negative charge must be

localized on the silicon atoms. A similar upfield shift was observed for 1-lithio-1-methyl-1-silafluorene (Table 3).²²

Summary

The potassium reduction of dichlorosilafluorene **4** rapidly forms an intermediate polysilafluorene. The Si–Si bonds of the polymer break down after further reaction with potassium to form dianion salt **3b** quantitatively. The downfield ^{29}Si chemical shift at 29.0 ppm and the C–C bond length equalization of the silole ring support the aromatic delocalization of electrons into the five-membered silole ring of silafluorenyl dianion salt **3b**. Dianion salt **3b** can undergo nucleophilic substitutions, single electron-transfer reactions, and radical reactions. Slow oxidation of **3b** leads to 1,1'-dipotassio-1,1'-bis(silafluorene) **16**, which has localized negative charges at the silicon atoms and thus is nonaromatic. Heating a DME/hexane solution of **3b** in the presence of 18-crown-6 leads to a diradical dianion salt **17**. Two unpaired electrons are singly delocalized into the benzene rings. The C–C bond length alternation in benzene rings suggests some loss of aromatic character in the benzene rings of this unusual diradical dianion.

Experimental Section

1,1-Dichloro-1-silafluorene (4). A solution of 2,2'-dibromobiphenyl (12.0 g, 38.5 mmol) in Et_2O (130 mL) was cooled to -78°C under an argon atmosphere, and *n*-BuLi (1.6 M in hexane, 50 mL, 80 mmol)

(22) Hong, J.-H.; Boudjouk, P.; Stoescu, I. *Organometallics* **1996**, *15*, 2179.

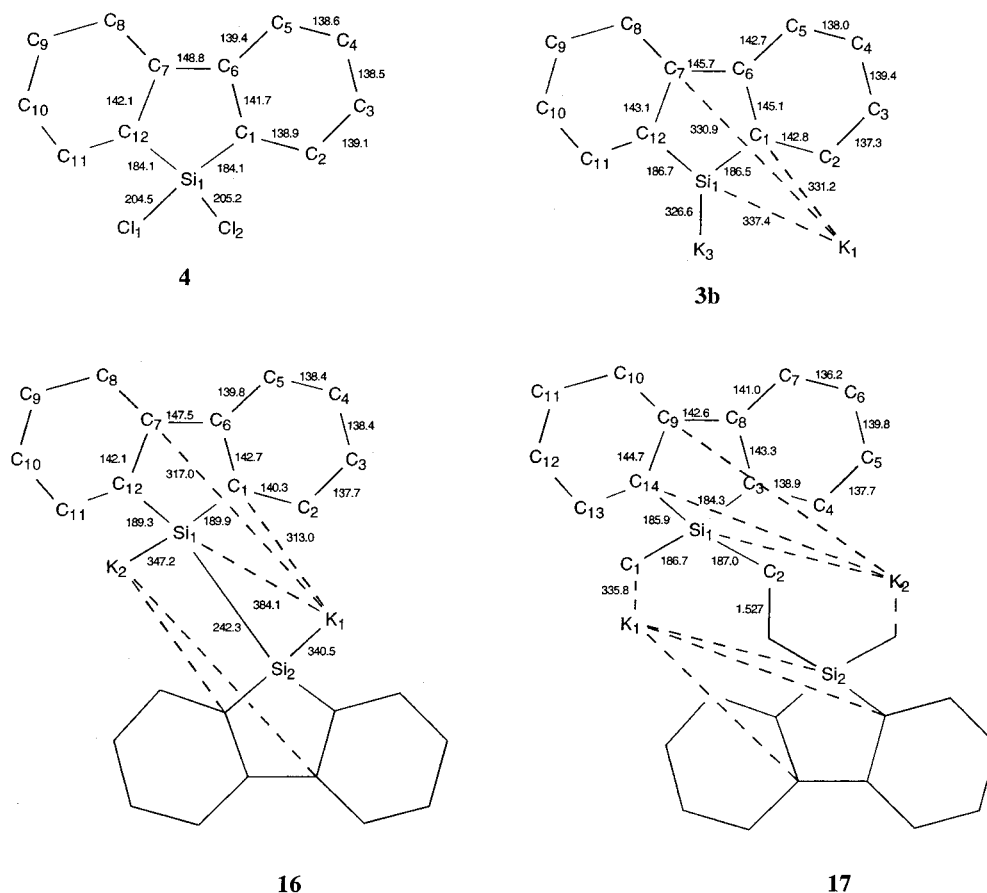

Figure 10. Comparison of selected bond lengths (pm) in 1,1-dichloro-1-silafluorene (**4**), dipotassio-1-silafluorene (**3b**), potassio-1-silafluorene dimer anion (**16**), and diradical dianion (**17**).

Table 1. Crystallographic Data^a for Compounds **3b**, **4**, **10**, **16**, **17**, and **20**

	3b · ² / ₃ hexane· ⁵ / ₃ (18-c-6)	4	10	16 ·4THF	17 ·2DME·2(18-c-6)	20
formula	C ₃₆ H _{57.33} K ₂ O ₁₀ Si	C ₁₂ H ₈ Cl ₂ Si	C ₄₂ H ₄₂ Si ₅	C ₄₀ H ₄₈ K ₂ O ₄ Si ₂	C ₆₀ H ₉₄ K ₂ O ₁₆ Si ₂	C ₂₈ H ₂₄ Si ₂
fw	756.44	251.17	687.21	727.16	1205.73	416.65
crystal system	triclinic	orthorhombic	triclinic	monoclinic	triclinic	monoclinic
space group	<i>P</i> $\bar{1}$	<i>Pnma</i>	<i>P</i> $\bar{1}$	<i>P2</i> ₁ / <i>c</i>	<i>P</i> -1	<i>P2</i> ₁ / <i>n</i>
<i>Z</i>	3	4	2	4	1	2
<i>T</i> , °C	−100	−140	−100	−140	−140	−100
<i>a</i> , Å	10.5459(9)	7.4375(6)	10.7130(10)	14.4065(13)	9.499(3)	9.4399(13)
<i>b</i> , Å	15.9281(12)	12.1540(10)	12.4592(14)	23.313(2)	12.856(4)	7.1505(10)
<i>c</i> , Å	17.8197(15)	12.7246(11)	13.6979(13)	12.3328(11)	14.846(4)	16.647(2)
α , deg	95.020(2)	90	94.279(2)	90	72.274(4)	90
β , deg	98.726(2)	90	94.337(2)	112.597(2)	76.170(5)	91.365(3)
γ , deg	96.053(2)	90	99.094(2)	90	68.932(4)	90
<i>V</i> , Å ³	2925.8(4)	1150.25(17)	1937.1(3)	3824.1(6)	1594.3(8)	11234(3)
<i>d</i> _{calc} , g cm ^{−3}	1.288	1.450	1.178	1.263	1.256	1.232
μ mm ^{−1}	0.327	0.629	0.213	0.349	0.540	0.170
θ range, deg	1.65–26.37	2.32–27.22	1.54–26.35	1.76–28.31	1.75–25.00	2.45–25.00
reflns collected	18371	6939	12476	17441	17197	7874
independent reflns	11090	1342	7264	8585	5460	1980
GOF (<i>F</i> ²)	1.026	1.054	1.000	0.941	1.071	1.014
<i>R</i> ₁ , ^b (<i>wR</i> ₂ ^c), %	6.30(16.90)	2.92(7.77)	4.51(12.19)	5.77(15.7)	7.03(19.46)	5.44(14.44)

^a Obtained with graphite-monochromated Mo *K*_α radiation ($\lambda = 0.71073$ Å). ^b $R_1 = \sum ||F_o| - |F_c|| / \sum |F_o|$. ^c $wR_2 = [\sum w(F_o^2 - F_c^2)^2 / \sum w(F_o^2)^2]$.

was added. The reaction solution was allowed to warm to room temperature and was stirred overnight. A cloudy yellow solution was obtained. The resulting solution was cannulated into a solution of SiCl₄ (20 mL, 174 mmol) in Et₂O (100 mL) at −95 °C. The reaction mixture was stirred at −95 °C for 4 h and then was stirred at room temperature overnight. A yellow solution and a white precipitate were obtained. The white precipitate, mostly LiCl, was removed by filtration under argon, and excess SiCl₄ and solvents were removed by vacuum. The residue was distilled using a Kugelrohr under vacuum to give 6.78 g (70.6%) of **4** at 120–130 °C/0.07 Torr. Selected data for **4**, ¹H NMR

(300.133 MHz, C₆D₆): $\delta = 7.43$ (d, 2H), 7.28 (d, 2H), 7.04 (t, 2H), 6.91 (t, 2H). ¹³C NMR (75.403 MHz, C₆D₆): $\delta = 145.8$ (C), 133.14 (CH), 132.8 (CH), 130.8 (C), 129.14 (CH), 121.4 (CH). ²⁹Si NMR (99.314 MHz, C₆D₆): $\delta = 5.7$.²³

Dipotassio-1-silafluorene (3b). A solution of 1,1-dichloro-1-silafluorene, **4** (6.78 g, 27.0 mmol), in THF (200 mL) was stirred with potassium metal (8.00 g, 204 mmol) at room temperature for 30 min under an argon atmosphere. A white precipitate formed rapidly. After

(23) For this and for all compounds reported, the NMR spectra indicated purities of at least 98%.

Table 2. ^1H and ^{13}C Chemical Shifts for **3b** and **4**

	3b (THF- d_6)	4 (THF- d_6)
^1H (ppm)	8.42 (br, 2H), 7.83 (br, 2H), 6.55 (br, 2H), 6.36 (br, 2H)	7.87 (d, 2H), 7.66 (d, 2H), 7.49 (t, 2H), 7.31 (t, 2H)
^{13}C (ppm)	167.9 (C), 134.4 (CH), 131.6 (C), 121.1 (CH), 115.6 (CH), 110.5 (CH)	146.8 (C), 133.5 (CH), 133.2 (CH), 131.4 (C), 129.4 (CH), 122.1 (CH)

Table 3. ^{29}Si Chemical Shifts for Various Silole Dichlorides, Silole Anions, and Silole Dianions

Dichloride	Dianion	Anion
 4, 5.7 ppm	 3b, 29.0 ppm	 -22.1 ppm ²²
 5.9 ppm ¹	 29.2 ppm ¹	 16, -38.0 ppm
 7.1 ppm ³	 68.5 ppm ³	
 8.1 ppm ⁴	 29.8 ppm ⁴	

stirring for 3h at room temperature, the reaction mixture turned red. Some reaction mixture was cannulated out and trapped with Me_3SiCl to give a mixture of silanes, **5**, **9**, and **10**, which were separated by preparative GPC (toluene elution) and recrystallized from toluene/hexane solutions. The remaining solution was then heated to 67 °C and stirred for 12 h. The color of the solution changed to a dark red. After removal of THF by vacuum, the residue was extracted with sodium-dried DME (150 mL), hexane (20 mL), and 18-crown-6 (7.20 g, 27.2 mmol). Red crystals of **3b** were obtained from the extracted solution after cooling at -20 °C. Selected data for **3b**, ^1H NMR (300.133 MHz, THF- d_6): δ = 8.42 (br, 2H, CH), 7.82 (br, 2H, CH), 6.54 (br, 2H, CH), 6.35 (br, 2H, CH). ^{13}C NMR (75.403 MHz, THF- d_6): δ = 167.9 (C), 134.4 (CH), 131.6 (C), 121.1 (CH), 115.6 (CH), 110.5 (CH). ^{29}Si NMR (99.314 MHz, THF- d_6): δ = 29.0. Selected data for **5**, ^1H NMR (300.133 MHz, CDCl_3): δ = 7.91 (d, 2H), 7.63 (d, 2H), 7.41 (t, 2H), 7.25 (t, 2H), 0.107 (s, 18H). ^{13}C NMR (75.403 MHz, CDCl_3): δ = 148.7, 139.5, 133.3, 128.4, 126.5, 121.2, -1.0. ^{29}Si NMR (99.314 MHz, CDCl_3): δ = -15.2, -42.2. MS (EI), m/z (%): 326.1 (65) (M^+), 253.1 (85) ($\text{M}^+ - \text{TMS}$). High-resolution MS (EI), calcd for $[\text{C}_{16}\text{H}_{18}\text{Si}]$ 326.1342, found 326.1335. Selected data for **9**, ^1H NMR (300.133 MHz, CDCl_3): δ = 7.92 (d, 4H), 7.77 (d, 4H), 7.48 (t, 4H), 7.33 (t, 4H), -0.414 (s, 18H). ^{13}C NMR (75.403 MHz, CDCl_3): δ = 148.8, 139.2, 133.8, 129.0, 126.8, 121.5, -1.8. ^{29}Si NMR (99.314 MHz, CDCl_3): δ = -13.3, -44.1. MS (EI), m/z (%): 506.2 (100) (M^+), 433.2 (95) ($\text{M}^+ - \text{SiMe}_3$), 253.1 (90) ($\text{M}^+/2$). Selected data for **10**, ^1H NMR (300.133 MHz, CDCl_3): δ = 7.92 (d, 2H), 7.69 (d, 2H), 7.61 (d, 4H), 7.46 (t, 2H), 7.30 (t, 4H), 7.27 (d, 2H), 7.21 (d, 4H), 7.00 (t, 4H), -0.490 (s, 18H). ^{13}C NMR (125.710 MHz, CDCl_3):

δ = 148.7, 148.5, 138.7, 137.3, 134.1, 133.4, 129.2, 128.5, 126.8, 126.4, 121.4, 121.3, -1.9. ^{29}Si NMR (99.314 MHz, CDCl_3): δ = -13.4, -43.3, -46.1. MS (MALDI, anthracene), m/z (%): 686.1 (56) (M^+), 613.1 (38) ($\text{M}^+ - \text{SiMe}_3$), 433.1 (100) ($\text{M}^+ - \text{SiMe}_3 - \text{SiC}_{12}\text{H}_8$).

Reaction of **3b with Me_3SiCl .** An excess of Me_3SiCl was added at 0 °C to a THF (150 mL) solution of **3b**, obtained from a reaction mixture of **4** (3.00 g, 12.0 mmol) and K (7.00 g, 179 mmol) in THF (100 mL). The volatiles were removed under reduced pressure, and the residue was extracted with toluene (400 mL). The toluene solution was washed with distilled water, dried with MgSO_4 , and filtered. Upon purifying by flash chromatography on silica gel (elution with hexane), white crystals of bis(trimethylsilyl) derivative **5** were obtained (3.84 g, 98.6%).

Reaction of **3b with EtBr.** A THF (100 mL) solution of **3b**, obtained from a reaction mixture of **4** (1.40 g, 5.58 mmol) and K (2.00 g, 51.2 mmol), was cannulated into a flask containing an excess of EtBr at room temperature. The volatiles were removed under reduced pressure, and the residue was extracted with toluene (400 mL) and filtered. White crystals of 1,1-diethyl-1-silafluorene **11** were obtained (1.08 g, 81.4%) after recrystallization from hexane. Selected data for **11**, ^1H NMR (300.133 MHz, C_6D_6): δ = 7.71 (d, 2H), 7.52 (d, 2H), 7.27 (t, 2H), 7.16 (t, 2H), 0.91 (q, 6H, CH_3), 0.82 (t, 4H, CH_2). ^{13}C NMR (75.403 MHz, CDCl_3): δ = 148.5, 137.3, 133.2, 130.1, 127.1, 120.8, 7.5, 3.8. ^{29}Si NMR (99.314 MHz, CDCl_3): δ = -1.1. MS (EI), m/z (%): 238.5 (77) (M^+), 209.4 (89) ($\text{M}^+ - \text{Et}$), 181.3 (100) ($\text{M}^+ - 2\text{Et}$). High-resolution MS (EI), calcd for $[\text{C}_{16}\text{H}_{18}\text{Si}]$ 238.1178, found 238.1168.

Reaction of **3b with MeI.** A THF (100 mL) solution of **3b**, obtained from a reaction of **4** (2.00 g, 7.97 mmol) and K (2.00 g, 51.2 mmol), was cannulated into a flask containing an excess of MeI at room temperature. The volatiles were removed under reduced pressure, and the residue was extracted with toluene (400 mL) and filtered. After preparative GPC (toluene elution) separation, three solid products were isolated in a ratio: 1,1-dimethyl-1-silafluorene **12** (0.71 g, 42%), dimer **13** (0.28 g, 18%), and disiloxane **14** (0.15 g, 9.3%). Selected data for **13**, ^1H NMR (300.133 MHz, C_6D_6): δ = 7.67 (d, 4H), 7.38 (d, 4H), 7.33 (t, 4H), 7.15 (t, 4H), 0.364 (s, 3H). ^{13}C NMR (125.710 MHz, CDCl_3): δ = 147.0, 135.8, 132.5, 130.8, 127.6, 120.5, -2.3. ^{29}Si NMR (99.314 MHz, CDCl_3): δ = -2.1. MS (EI), m/z (%): 390.1 (53) (M^+), 375.1 (76) ($\text{M}^+ - \text{Me}$). High-resolution MS (EI), calcd for $[\text{C}_{26}\text{H}_{22}\text{Si}_2]$ 390.1259, found 390.1252. Selected data for **14**: ^1H NMR (300.133 MHz, C_6D_6): δ = 7.78 (d, 4H), 7.67 (d, 4H), 7.45 (t, 4H), 7.29 (t, 4H), 0.587 (s, 3H); ^{13}C NMR (125.710 MHz, CDCl_3): δ = 147.9, 136.4, 133.5, 131.9, 128.6, 121.4, -2.9; ^{29}Si NMR (99.314 MHz, CDCl_3): δ = -4.8, -1.1; MS (EI), m/z (%): 406.1 (74) (M^+), 391.1 (100) ($\text{M}^+ - \text{Me}$); High-resolution MS (EI), calcd for $[\text{C}_{26}\text{H}_{22}\text{Si}_2\text{O}]$ 406.1209, found 406.1206.

Reaction of **3b with Benzaldehyde.** A THF (100 mL) solution of **3b**, obtained from a reaction mixture of **4** (2.00 g, 7.97 mmol) and K (2.00 g, 51.2 mmol), was cannulated into a Schlenk flask containing a THF (100 mL) solution of benzaldehyde (1.69 g, 15.9 mmol) at -78 °C. The reaction mixture was stirred at -78 °C for 2 h and then was stirred at room temperature overnight. Excess methanol (100 mL) was added to quench the reaction. The solution was neutralized with dilute aqueous HCl. The volatiles were removed under reduced pressure, and the residue was extracted with toluene (200 mL). The resulting solution was washed with distilled water, dried with MgSO_4 , and filtered. After preparative GPC column (toluene elution) separation, two major products were obtained: 1,2-diphenyl-1,2-ethanediol (1.65 g, 96.8%) and oligosilafluorene (**15**) (0.81 g, 55.9%). The structure of the 1,2-diol was confirmed by ^1H NMR²⁴ and X-ray crystallography. The ratio of two diastereomers of 1,2-diol, meso:[*R,R*]/[*S,S*], is 5:4 based on ^1H NMR data. Selected data for **15**, ^1H NMR (300.133 MHz, CDCl_3): δ = 7.54–6.50 (br). ^{29}Si NMR (99.314 MHz, CDCl_3): δ = -12.1 (br).

(24) Pouchert, C. J.; Behnke, J. *The Aldrich Library of ^{13}C and ^1H FT NMR Spectra*; Aldrich Chemical Co., Inc.: Milwaukee, WI, 1993; Vol. 2, pp 336C, 337A.

GPC (polystyrene standard, toluene as the mobile phase): $M_n = 905$, $M_w = 1198$ ($PI = 1.324$).

1,1'-Dipotassio-1,1'-bis(silafluorene) (16) from Oxidation of 3b.

A saturated solution of **3b** in THF (150 mL)/hexane (20 mL) was stored in a Schlenk flask at $-20\text{ }^\circ\text{C}$ for two months. Dark brown crystals of **16** formed in the bottom of the flask. The remaining solution was separated and treated with trimethylchlorosilane, and trisilane **5** was obtained. The crystals were then treated with trimethylchlorosilane. The volatiles were removed under reduced pressure, and the residue was extracted with toluene (100 mL). After removal of toluene, white solid tetrasilane **9** was obtained. Selected data for **16**, $^1\text{H NMR}$ (499.895 MHz, THF- d_8): $\delta = 8.05$ (br, 4H), 8.00 (br, 4H), 6.97 (br, 4H), 6.95 (br, 4H). $^{13}\text{C NMR}$ (125.710 MHz, THF- d_8): $\delta = 167.2$ (C), 142.2 (C), 132.5 (CH), 120.6 (CH), 119.6 (CH), 119.2 (CH). $^{29}\text{Si NMR}$ (99.314 MHz, THF- d_8): $\delta = -38.0$.

Diradical Dianion Salts 17 and 18 from Thermal Decomposition of 3b. A saturated solution of **3b** in DME (100 mL)/hexane (20 mL)/K (5.00 g, 127 mmol)/18-crown-6 (distilled over Na metal) (3.00 g, 11.35 mmol) was heated at $60\text{--}70\text{ }^\circ\text{C}$ for 12 h in a closed flask without stirring. The color of the solution changed from a dark red to a dark green, and a gray precipitate formed. Some of the green solution (20 mL) was isolated and cooled at $-20\text{ }^\circ\text{C}$. Dark green crystals of **17** were obtained. Trapping reactions of the green solution with either I_2 , MeOH, or EtOD gave **19** as the only major product. The remaining green solution was continuously heated at $60\text{--}70\text{ }^\circ\text{C}$ for a week. Trapping reactions of the resulting solution with I_2 gave a mixture of two products, **19** and **20**, in a ratio of 10:1. The workup for **19** and **20** was carried out by treating the final green solution with excess I_2 followed by mixing with toluene (200 mL). The toluene solution was washed with distilled water, dried with MgSO_4 , and filtered. After separation by preparative GPC (toluene elution), both **19** and **20** were obtained as white crystals after removal of toluene. Selected data for **19**, $^1\text{H NMR}$ (300.133 MHz, CDCl_3): $\delta = 7.80$ (d, 4H), 7.56 (d, 4H), 7.42 (t, 4H), 7.24 (t, 4H), 0.888 (s, 4H, $-\text{CH}_2\text{CH}_2-$), 0.354 (s, 6H, $-\text{CH}_3$). $^{13}\text{C NMR}$ (75.403 MHz, DEPT 90/135, CDCl_3): $\delta = 148.2$ (C), 137.8 (C), 133.0 (CH), 130.2 (CH), 127.3 (CH), 120.8 (CH), 6.2 (CH_2), 5.6 (CH_3). $^{29}\text{Si NMR}$ (99.314 MHz, CDCl_3): $\delta = 1.6$. MS (EI), m/z (%): 418.1 (45) (M^+), 195.0 ($(\text{M}^+ - \text{CH}_2\text{CH}_2)/2$)(100). High-resolution MS (EI), calcd for $[\text{C}_{28}\text{H}_{26}\text{Si}_2]$ 418.1573, found 418.1575. Selected data for **20**, $^1\text{H NMR}$ (300.133 MHz, CDCl_3): $\delta = 7.90$ (d, 4H), 7.87 (d, 4H), 7.51 (t, 4H), 7.36 (t, 4H), 1.48 (s, 8H, $-\text{CH}_2\text{CH}_2-$). $^{13}\text{C NMR}$ (75.403 MHz, CDCl_3): $\delta = 148.2$, 137.5, 133.3, 130.6, 127.5, 121.1, 7.2. $^{29}\text{Si NMR}$ (99.314 MHz, CDCl_3): $\delta = -5.0$. MS (EI), m/z (%): 416.1 (52) (M^+), 360.1 ($\text{M}^+ - 56$)(100). High-resolution MS (EI), calcd for $[\text{C}_{28}\text{H}_{24}\text{Si}_2]$ 416.1416, found 416.1428.

EPR Spectrum of 17. EPR data of **17** were acquired with a Bruker ESP 300E X-band spectrometer using 100 Hz modulation frequency. A gaussmeter calibrated with solid diphenylpicrylhydrazyl was used to measure the field strength for g -value determination. Acquisition parameters were adjusted on a case-by-case basis to provide sufficient spectral resolution. Sample solution concentrations were adjusted to

reduce line broadening due to spin exchange and thus achieve better spectral resolution. The best data were obtained from samples in a DME/hexane (8/1 volume ratio) mixed solvent; less useful data were obtained with THF as solvent. Low-temperature data were obtained at 77 K by immersion of the sample into a quartz dewar insert containing liquid nitrogen.

1,1-Dimethyl-1-silafluorene (12). A solution of 2,2'-dibromobiphenyl (12.0 g, 38.5 mmol) in Et_2O (150 mL) was cooled to $-78\text{ }^\circ\text{C}$ under an argon atmosphere, and $n\text{-BuLi}$ (1.6 M in hexane, 50 mL, 80 mmol) was added. The reaction solution was allowed to warm to room temperature and was stirred overnight. The solution was cooled to $-78\text{ }^\circ\text{C}$, and Me_2SiCl_2 (10.0 g, 77.5 mmol) was added. The reaction mixture was stirred at $-78\text{ }^\circ\text{C}$ for 1 h and then was stirred at room temperature overnight. A yellow solution with a white precipitate was obtained. The white precipitate, mostly LiCl, was removed by filtration under an argon atmosphere, and excess Me_2SiCl_2 and solvents were removed under vacuum. The residue was distilled using Kugelrohr under vacuum to give 7.60 g (94.1%) of **12** at $100\text{--}130\text{ }^\circ\text{C}$, 0.07 Torr. Recrystallization from hexane gave **12** as a colorless solid. Selected data for **12**, $^1\text{H NMR}$ (300.133 MHz, CDCl_3): $\delta = 7.81$ (d, 2H), 7.62 (d, 2H), 7.42 (t, 2H), 7.27 (t, 2H), 0.417 (s, 6H). $^{13}\text{C NMR}$ (75.403 MHz, CDCl_3): $\delta = 147.8$, 138.9, 132.7, 130.2, 127.3, 120.8, -3.2 . $^{29}\text{Si NMR}$ (99.314 MHz, CDCl_3): $\delta = -0.6$. MS (EI), m/z (%): All data are similar to those of the previous literature reports.^{12,25}

Reaction of 12 with Lithium. A solution of 1,1-dimethyl-1-silafluorene, **12** (2.03 g, 9.67 mmol), in THF (50 mL) was stirred with lithium metal (0.25 g, 36.0 mmol) at room temperature under argon. The color of the solution changed from colorless to bluish-green in 30 min. Trapping a sample of the solution with either I_2 or MeOH gave back **12**. The solution was continuously stirred for a week. A sample of the resulting solution was oxidized with I_2 to give three major products, **12**, **19**, and **20**, in a 15:4:1 ratio based on $^1\text{H NMR}$ data.

Acknowledgment. The authors thank the National Science Foundation and the sponsors of the Organosilicon Research Center for financial support, NSF CHE-9522057 for computational support, NSF CHE-8813550, NSF CHE-9629688, NSF CHE-9208463, NIH 1 S10 RR0 4981-01, and NIH 1 S10 RR0 8389-01 for NMR support, and NSF CHE-9508244 for EPR support. The authors also thank Nguyet T. Tran, Robert W. Clark, and Michael A. Kozee for assistance with X-ray crystallography.

Supporting Information Available: X-ray crystallographic data for structure determination of **3b**, **4**, **10**, **16**, **17**, and **20** (CIF). This material is available free of charge via the Internet at <http://pubs.acs.org>.

JA011821M

(25) Jorcal, L. J. *Organomet. Chem.* **1967**, *10*, 175.